

CIRCUITO ELÉCTRICO

ESQUEMA DE CABLEADO

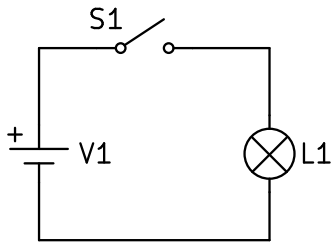

1

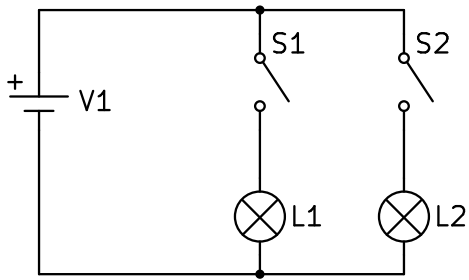
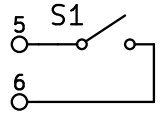
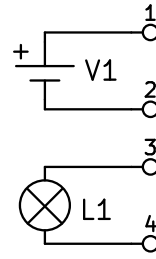

2

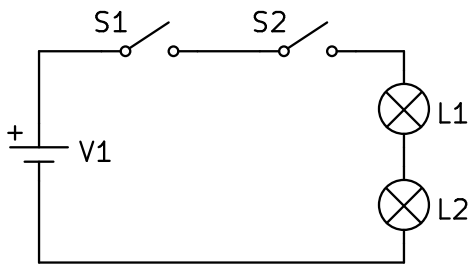
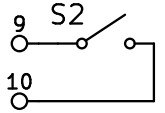
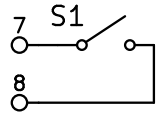
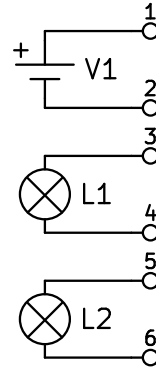

3

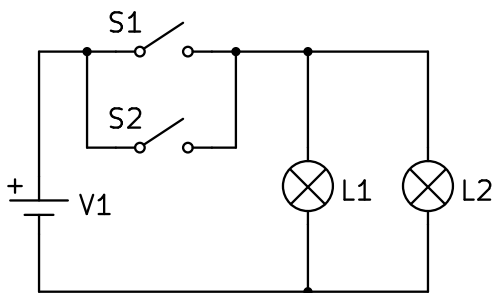
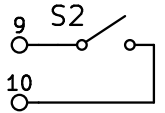
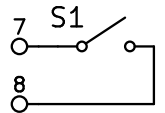
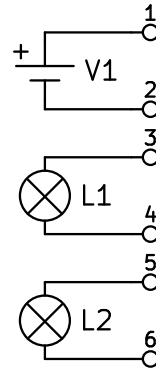

4

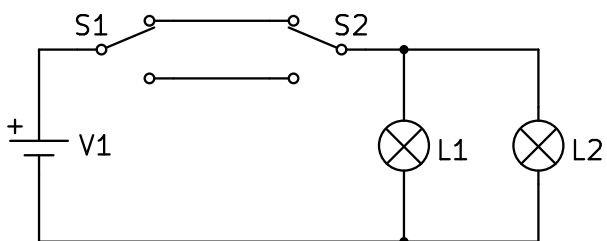
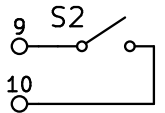
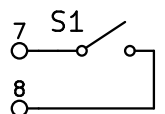
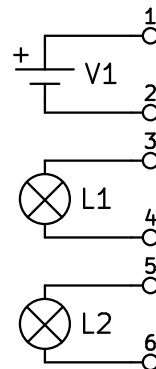

5

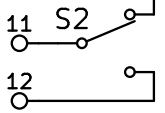
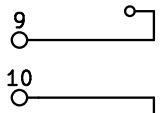
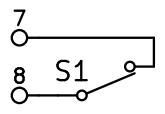
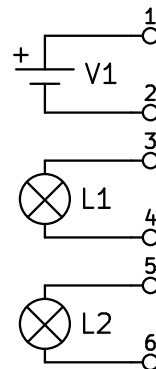

CIRCUITO ELÉCTRICO

ESQUEMA DE CABLEADO

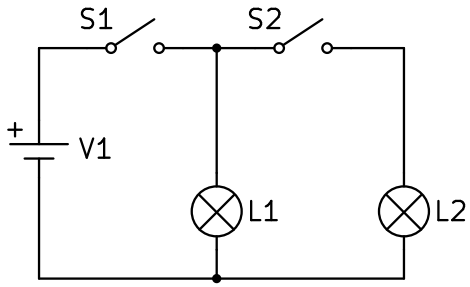

6

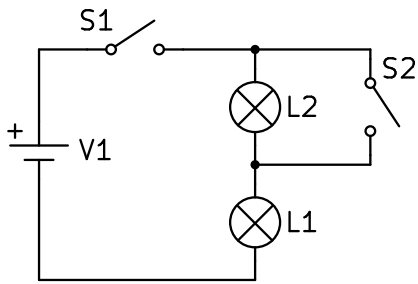
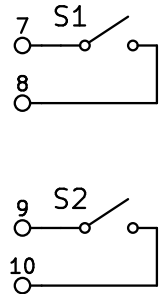
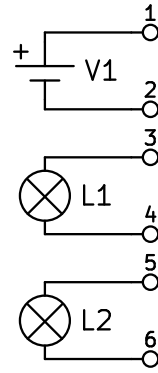

7

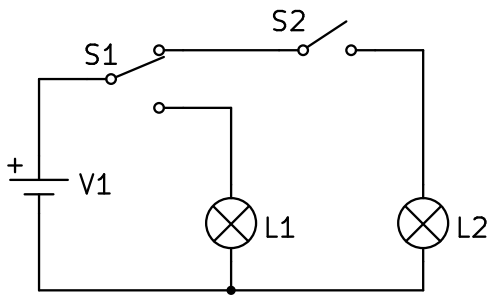
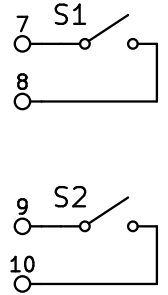
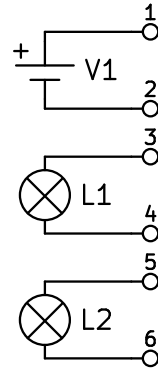

8

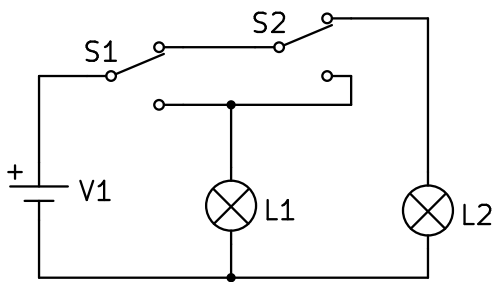
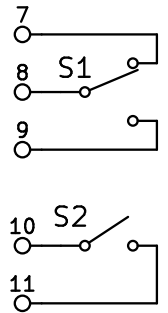
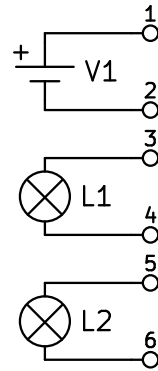

9

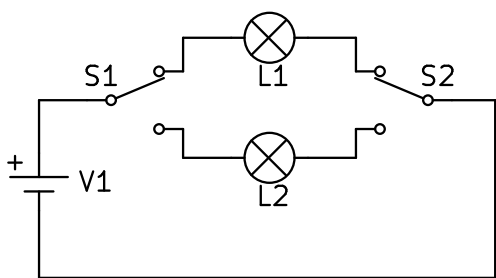
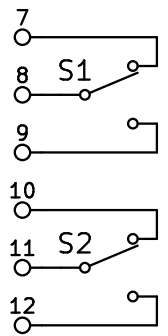
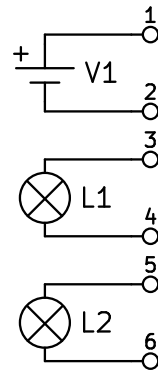

10

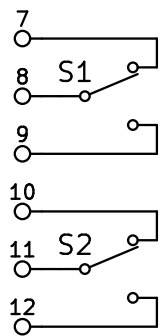
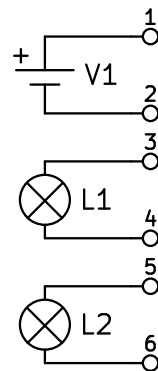

CIRCUITO ELÉCTRICO

ESQUEMA DE CABLEADO

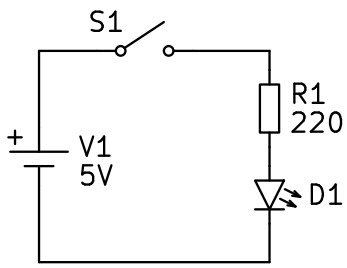

11

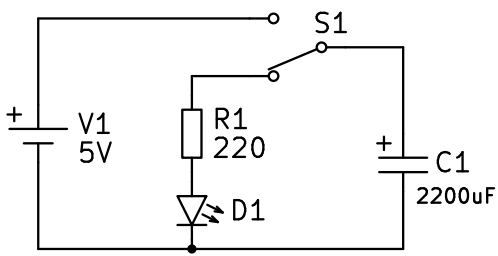
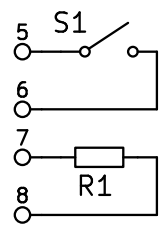
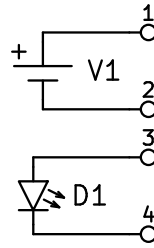

12

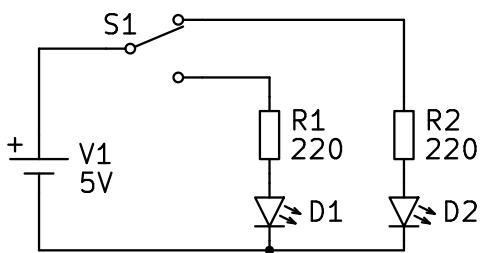
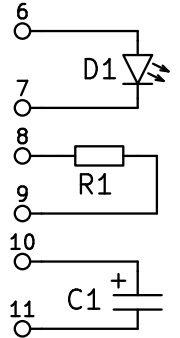
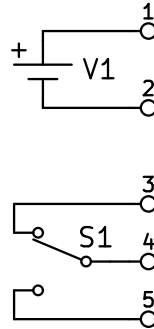

13

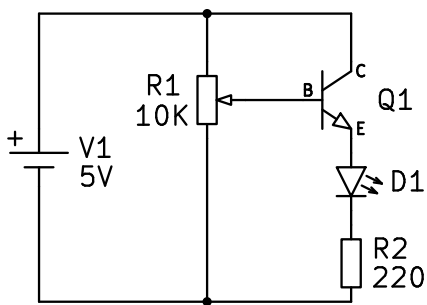
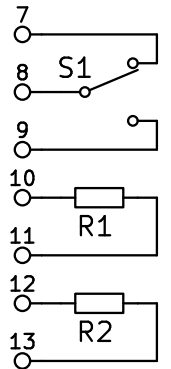
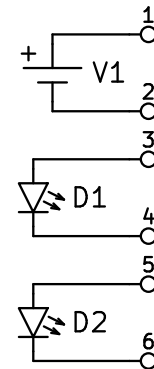

14

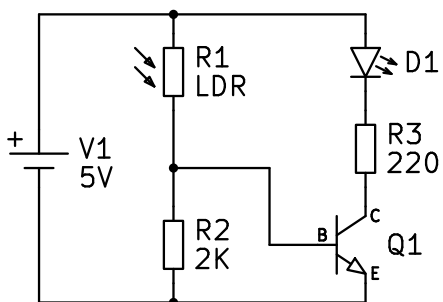
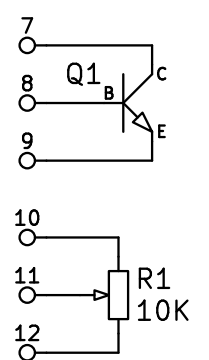
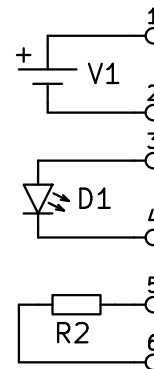

15

